

Fax

+41 (0)21 791-64-89

E-mail: infos@tiffany-time.com

Atelier Tiffany-Time

www.tiffany-time.com



Vous trouverez chez nous un vaste assortiment de verres provenant des manufactures suivantes:

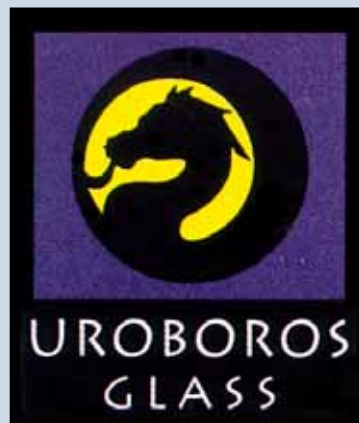

**Mettez du verre
dans votre
univers !**



Le verre est vendu à la coupe, au dm². Nous vendons également du verre Float de 3 mm et du miroir de 2 et 3 mm



00-001-xx	Cabochon rond	6 mm
00-002-xx	Cabochon rond	8 mm
00-003-xx	Cabochon rond	10 mm
00-004-xx	Cabochon rond	12 mm
00-005-xx	Cabochon rond	15 mm
00-006-xx	Cabochon rond	18 mm
00-007-xx	Cabochon rond	25 mm
00-008-xx	Cabochon rond	30 mm

00-010-xx	Cabochon oval	18/13 mm
00-011-xx	Cabochon oval	24/14 mm
00-012-xx	Cabochon oval	25/18 mm
00-013-xx	Cabochon oval	36/19 mm
00-014-xx	Cabochon oval	45/18 mm

Lors de votre commande, remplacer les «xx» par le numéro de la couleur désirée.

Attention: Les couleurs représentées ci-dessus peuvent subir des variations lors de l'impression du catalogue.

Fax

+41 (0)21 791-64-89

E-mail: infos@tiffany-time.com

Atelier Tiffany-Time

www.tiffany-time.com

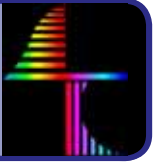

00-020-xx	Perle à facettes	15 mm
00-021-xx	Perle à facettes	20 mm
00-022-xx	Perle à facettes	25 mm
00-023-xx	Perle à facettes	30 mm
00-024-xx	Perle à facettes	35 mm
00-025-xx	Perle à facettes	40 mm
00-026-xx	Perle à facettes	50 mm

00-030-xx	Perle à facettes	18 mm
00-031-xx	Perle à facettes	20 mm
00-032-xx	Perle à facettes	25 mm
00-033-xx	Perle à facettes	30 mm
00-034-xx	Perle à facettes	40 mm

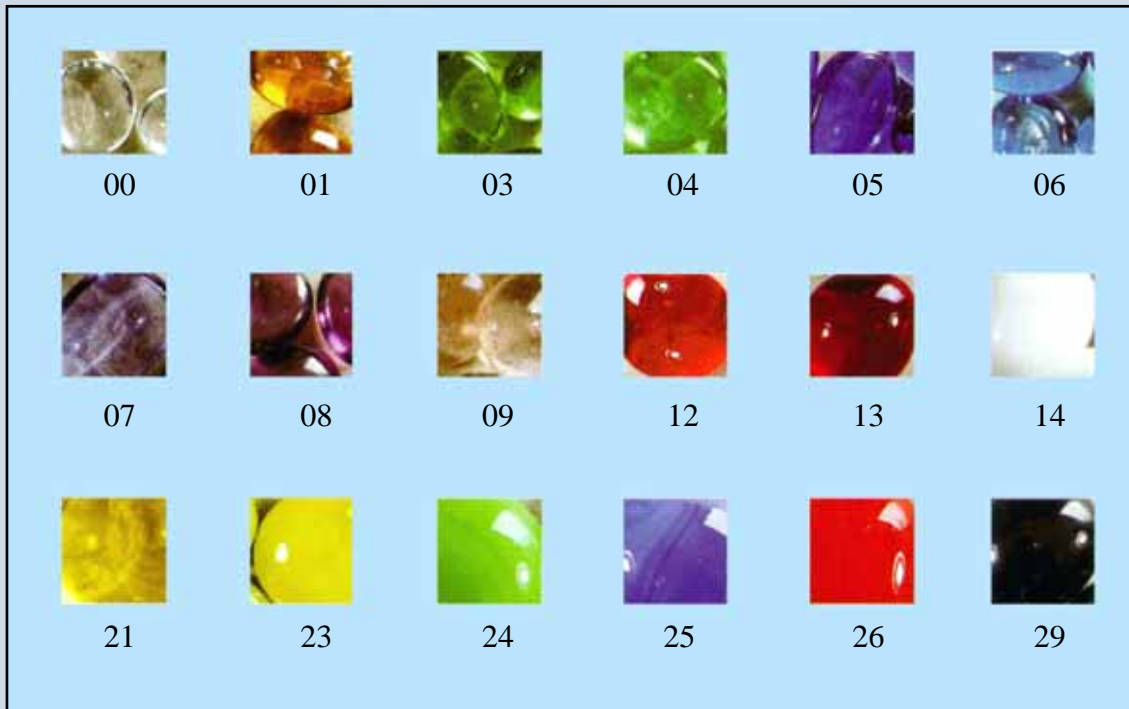

00-050 + 51	Perle irrégulière	12 - 13 mm
00-053 + 54	Perle irrégulière	15 - 16 mm
00-055 + 56	Perle irrégulière	30 - 40 mm

VERRE 2011



Atelier Tiffany-Time

www.tiffany-time.com

Téléphone

+41 (0)21 791-56-49

E-mail: infos@tiffany-time.com

VERRE 2011

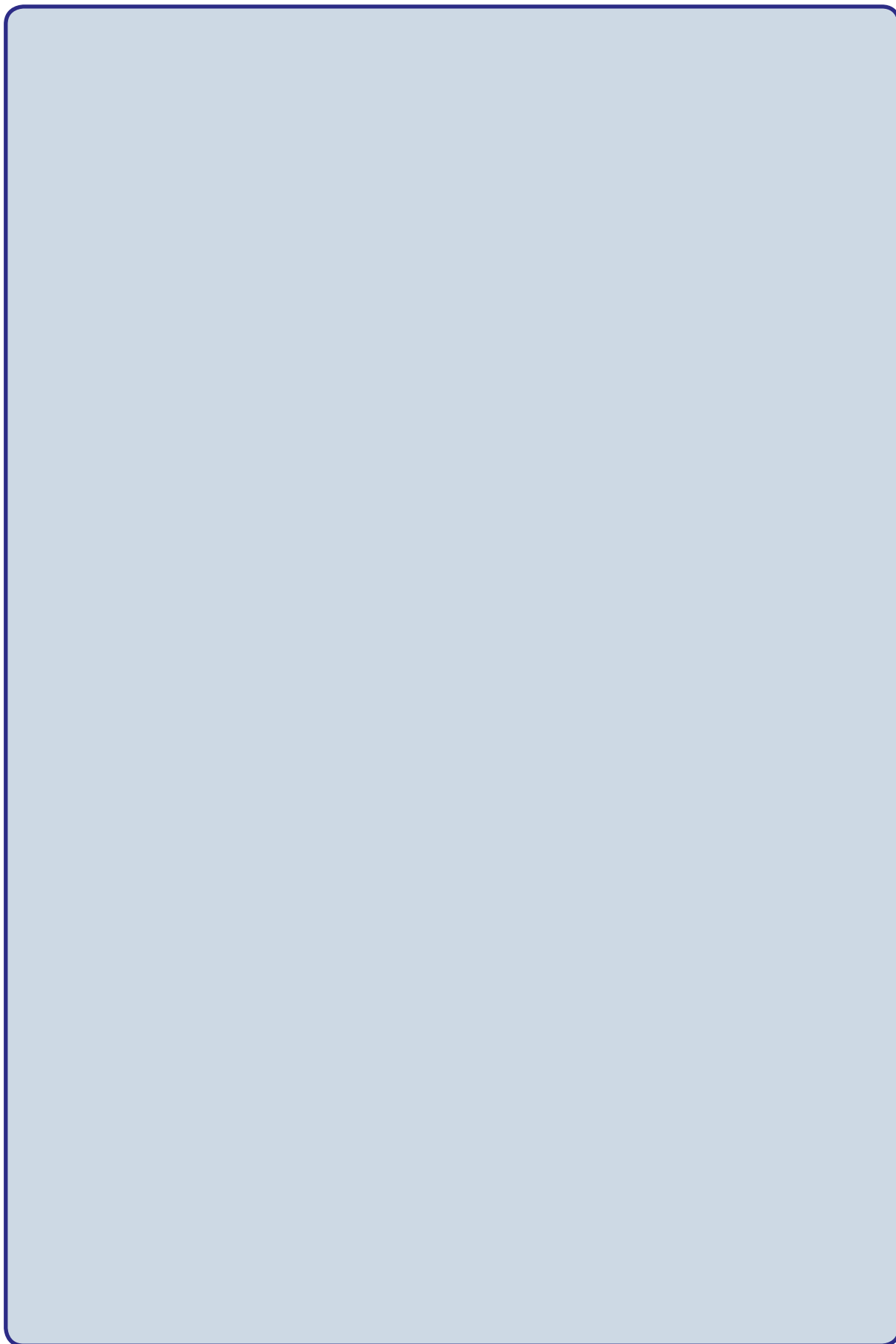

00

Rue de l'Horloge 1

CH-1095 LUTRY (Suisse)

Fax

+41 (0)21 791-64-89

E-mail: infos@tiffany-time.com

Atelier Tiffany-Time

www.tiffany-time.com



00-100-01 Biseauté 19,2 X 19,2 mm
00-100-02 Biseauté 19,2 X 25,4 mm
00-100-03 Biseauté 19,2 X 50,8 mm
00-100-04 Biseauté 19,2 X 76,2 mm
00-100-05 Biseauté 19,2 X 127 mm



00-100-21 Biseauté 25,4 X 25,4 mm
00-100-22 Biseauté 25,4 X 50,8 mm
00-100-23 Biseauté 25,4 X 76,2 mm
00-100-24 Biseauté 25,4 X 101,6 mm
00-100-25 Biseauté 25,4 X 127 mm

00-100-11 Biseauté 25,4 X 25,4 mm
00-100-12 Biseauté 25,4 X 50,8 mm
00-100-13 Biseauté 25,4 X 76,2 mm
00-100-14 Biseauté 25,4 X 101,6 mm
00-100-15 Biseauté 25,4 X 127 mm

00-100-31 Biseauté 38,1 X 38,1 mm
00-100-32 Biseauté 38,1 X 50,8 mm
00-100-33 Biseauté 38,1 X 76,2 mm
00-100-34 Biseauté 38,1 X 101,6 mm
00-100-35 Biseauté 38,1 X 127 mm

00-100-41 Biseauté 50,8 X 50,8 mm

00-105-01 B. miroir 38,1 X 38,1 mm
00-105-02 B. miroir 38,1 X 76,2 mm
00-105-03 B. miroir 38,1 X 101,6 mm
00-105-04 B. miroir 38,1 X 152,3 mm

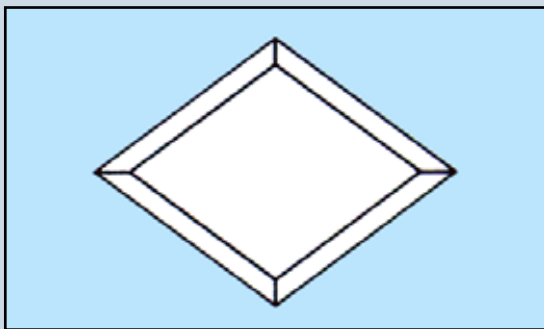

00-110-01 Biseauté 38,1 x 63,5 mm
00-110-02 Biseauté 44,5 x 76,2 mm
00-110-03 Biseauté 50,8 x 101,6 mm
00-110-04 Biseauté 76,2 x 127 mm
00-110-05 Biseauté 50,8 x 152,3 mm
00-110-06 Biseauté 50,8 x 228,6 mm

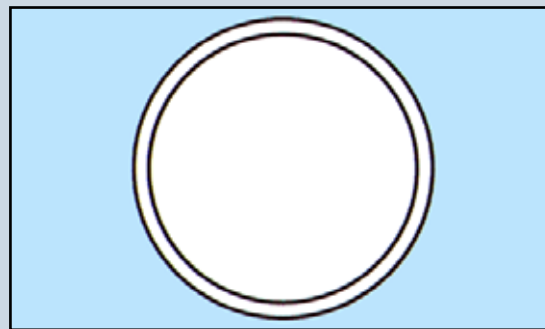

00-120-01 Biseauté 50,8 mm diam.
00-120-02 Biseauté 76,2 mm diam.
00-120-03 Biseauté 101,6 mm diam.
00-120-04 Biseauté 127 mm diam.
00-120-05 Biseauté 152,3 mm diam.

VERRE 2011

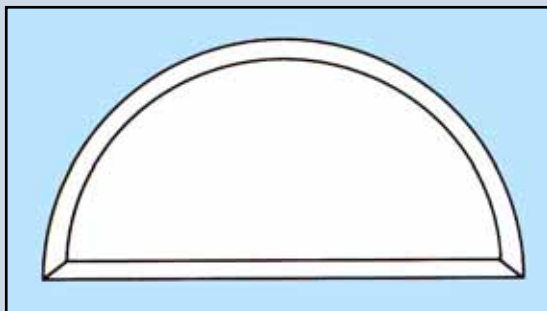

- 00-130-01 Biseauté 50,8 mm diam.
- 00-130-02 Biseauté 76,2 mm diam.
- 00-130-03 Biseauté 101,6 mm diam.
- 00-130-04 Biseauté 127 mm diam.
- 00-130-05 Biseauté 152,3 mm diam.

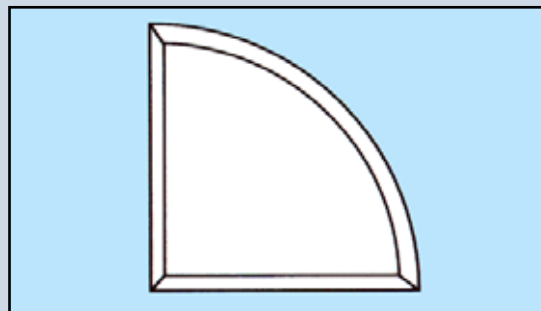

- 00-140-01 Biseauté 38,1 mm rayon
- 00-140-02 Biseauté 50,8 mm rayon
- 00-140-03 Biseauté 62 mm rayon
- 00-140-04 Biseauté 76,2 mm rayon

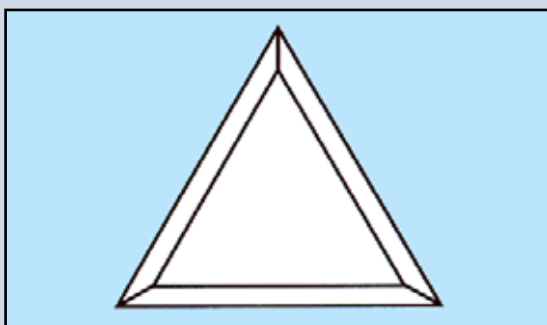

- 00-150-01 Biseauté 76,2 mm côté
- 00-150-02 Biseauté 101,6 mm côté

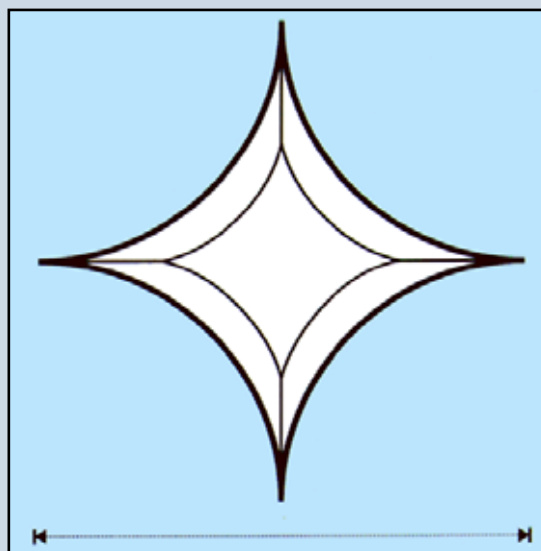

- 00-160-01 Biseauté 51 X 51 mm
- 00-160-02 Biseauté 65 X 65 mm
- 00-160-03 Biseauté 110 X 110 mm

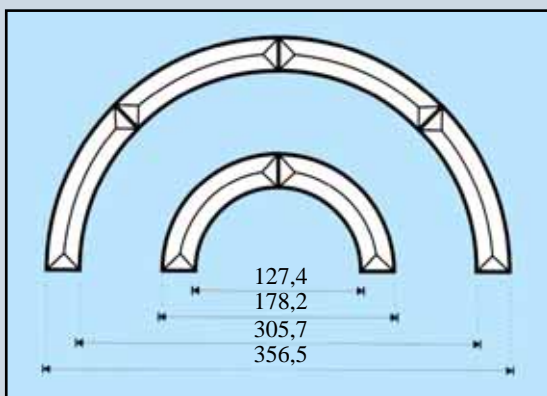

- 00-170-01 Biseauté petit 2 pièces
- 00-170-02 Biseauté grand 4 pièces

Fax

+41 (0)21 791-64-89

E-mail: infos@tiffany-time.com

Atelier Tiffany-Time

www.tiffany-time.com

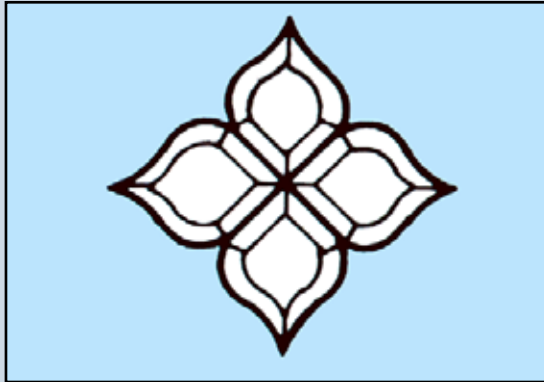
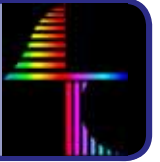

00-300-01 Set 4 pces 21,5 X 21,5 cm

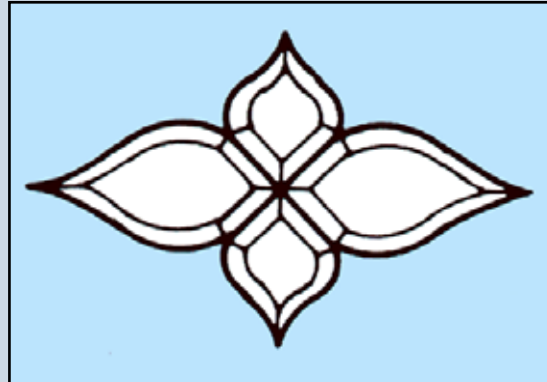

00-300-02 Set 4 pces 21,5 X 35,5 cm



00-300-03 Set 9 pces 21,5 X 35,5 cm

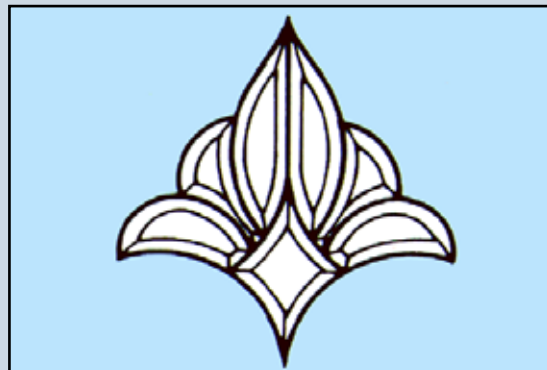

00-300-04 Set 7 pces 29,2 X 32,4 cm

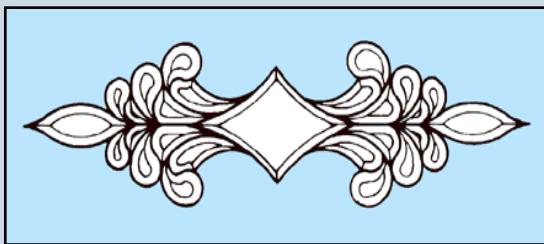

00-300-05 Set 27 pces 23,5 X 81,3 cm



00-300-06 Set 10 pces 32,4 X 19,7 cm

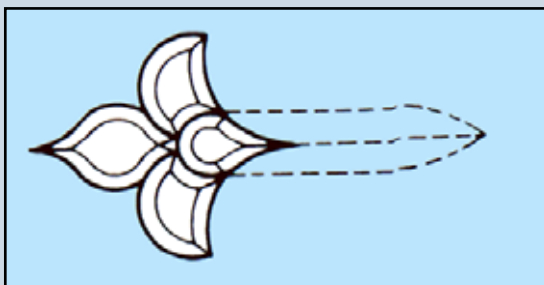

00-300-07 Set 4 pces 17,8 X 20,3 cm

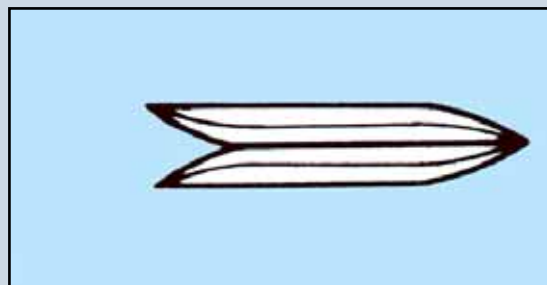

00-300-08 Set 4 pces 5,1 X 20,3 cm



Atelier Tiffany-Time

www.tiffany-time.com

Téléphone

+41 (0)21 791-56-49

E-mail: infos@tiffany-time.com

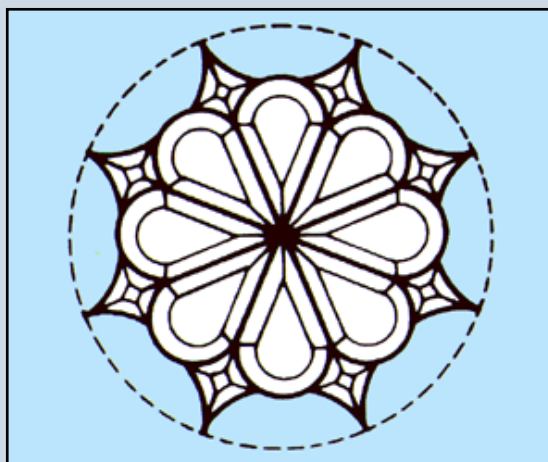

00-300-09 Set 16 pces 29,8 cm diam.

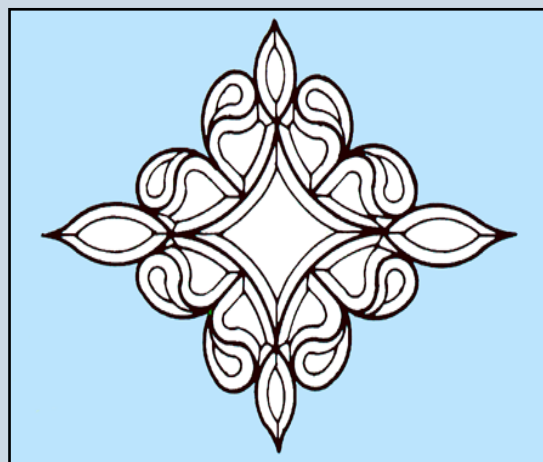

00-300-10 Set 21 pces 40,6 X 52 cm

VERRE 2011

Conseils : Pour sertir les verres biseautés, utilisez de préférence la bande de cuivre avec l'intérieur noir ou argenté (article No: 20-105-10 et suivants).

00

Rue de l'Horloge 1

CH-1095 LUTRY (Suisse)